

LIBERTY™ PORTABLE RESTROOM ASSEMBLY INSTRUCTIONS

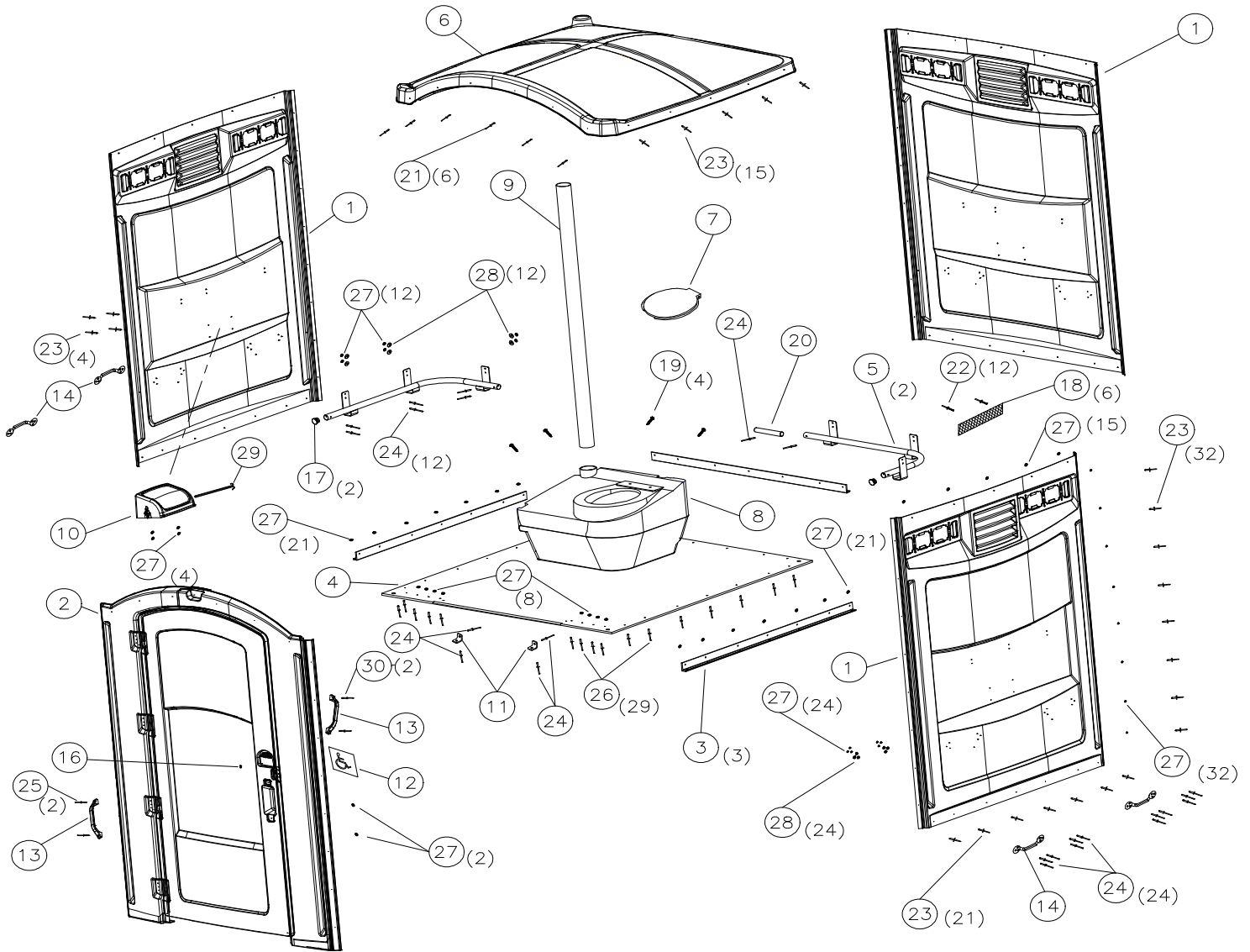

2530 Xenium Lane North, Minneapolis, MN 55441
 Telephone: 763-553-1900 Fax: 763-553-1905
 800-328-3332 / www.satelliteindustries.com

Parts List

30	17030	2	RIVET, AVDEL BLACK
29	16844	1	SPINDLE, PAPERGUARD II
28	11361	36	WASHER, 3/16" FENDER
27	11315	139	WASHER, 3/16" RIVET STNLS
26	14351	29	RIVET, #610 CCP
25	10812	2	RIVET, #612 ALUM
24	11270	42	RIVET, #68 STNLS
23	11054	72	RIVET, #68 AAL POP
22	15337	12	RIVET, .195" PLASTIC EXPANDING
21	14427	6	RIVET, #66 LSH W/LOCK MANDREL
20	15589	1	TUBE, HANDRAIL INSERT
19	13860	4	SCREW #14 x 1-1/2" W/WSH GOLD
18	14112	6	SCREEN, 3.8 x 15.25 PLSTC VENT
17	15588	2	PLUG, 1-1/4" HOLE
16	10161	1	PLUG, 1/2" ROUND BLACK PLASTIC
15	18041	1	INSTRUCTIONS, LIBERTY (not shown)
14	14611	4	HANDLE, RESTROOM LIFT
13	16807	2	HANDLE, MAX3000 HOVER
12	14401	1	DECAL, WHEELCHAIR ACCESSIBLE
11	16175	2	BRACKET, L 1" STNLS
10	17082	1	HOOD, PAPERGUARD II
9	13796	1	VENT PIPE, 3"x 65-1/2" GREY
8	14508	1	TANK, FREEDOM2 35 GAL CAPACITY
7	10570	1	SEAT, TOILET
6	18036	1	ROOF, LIBERTY
5	18038	2	HANDRAIL, LIBERTY
4	18037	1	FLOOR, LIBERTY
3	18039	3	ANGLE, PLSTC LIBERTY
2	*	1	FRONT ASSY, LIBERTY
1	*	3	SIDE PANEL, LIBERTY
ITEM #	PART #	QTY	DESCRIPTION

* 18012 FRONT ASSY, LIBERTY FOREST	* 18032 SIDE PANEL, LIBERTY FOREST
* 18013 FRONT ASSY, LIBERTY TEAL	* 18033 SIDE PANEL, LIBERTY TEAL
* 18014 FRONT ASSY, LIBERTY RBLUE	* 18034 SIDE PANEL, LIBERTY RBLUE
* 18015 FRONT ASSY, LIBERTY SAND	* 18035 SIDE PANEL, LIBERTY SAND

INTRODUCTION

Satellite portable restrooms must be assembled according to approved assembly procedures. Avoid variations in assembly procedures which could adversely affect product life and warranty.

All references to front, left, right, and rear are looking at the door of the unit from the outside.

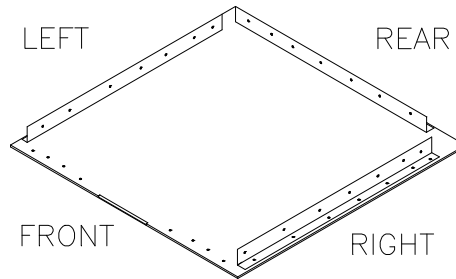

Tools:

- Standard screwdriver
- #4 Phillips Head Driver Bit
- 3/8" [9.53 mm] Hex Driver bit
- Drill Electric or Cordless
- Pop Rivet Gun
- 1/4" (0.250") [6 mm] Drill bit
- #10 (0.193") [5 mm] Drill bit

HELPFUL HINTS:

- Keep panels out of direct sunlight.
- Don't open up all of your kit boxes. Open up only enough kit boxes to assemble the number of toilets you are currently working on. **KEEP PARTS ORGANIZED.**
- Staging parts will minimize assembly time.
- Keep driver as upright as possible when driving lag screws for panel to tank attachment.

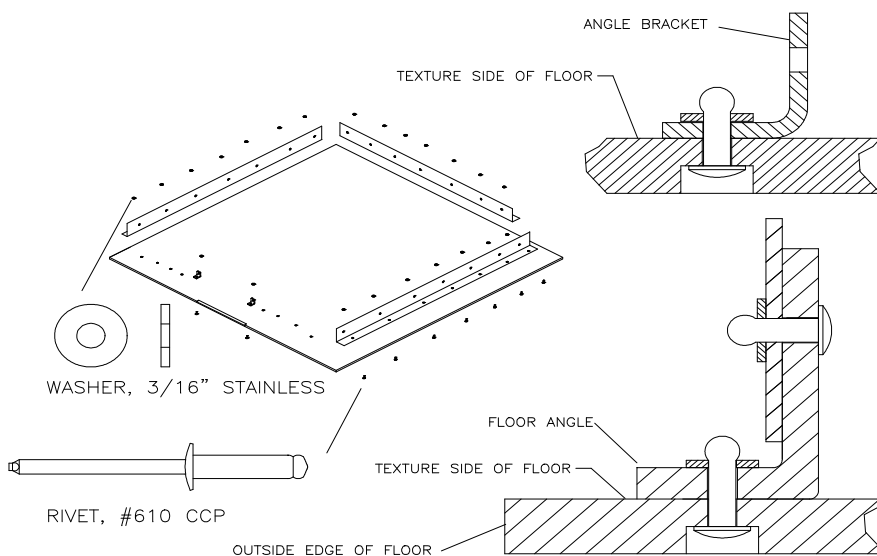

Install Angles on Floor.

Place floor P/N 18037 on a table or box with textured side up. Layout angles P/N 18039 with short flange down on floor. Align holes drilled in angle with holes drilled in floor.

Rivet angles to floor using #610 CCP rivets P/N 14351. Install rivet from bottom of floor up through angle with back-up washer P/N 11315 on top surface of angle.

Finish riveting angles to floor.

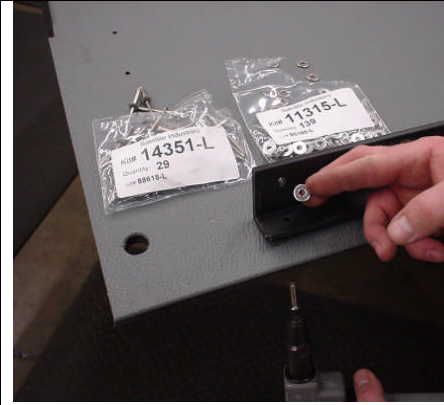

Install Panels on Floor Angles.

Rivet the left panel to the floor angles by installing #68 large flange aluminum rivets P/N 11054 from inside unit through hole in angle and hole in panel. Place a back-up washer P/N 11315 onto rivet outside of panel and set rivet.

Rivet the rear and right panel (all panels P/N 18034) to floor angle through two end holes using #68 large flange aluminum rivets and back-up washers.. Position panel on outside of angle so holes in bottom of panel match holes in angle.

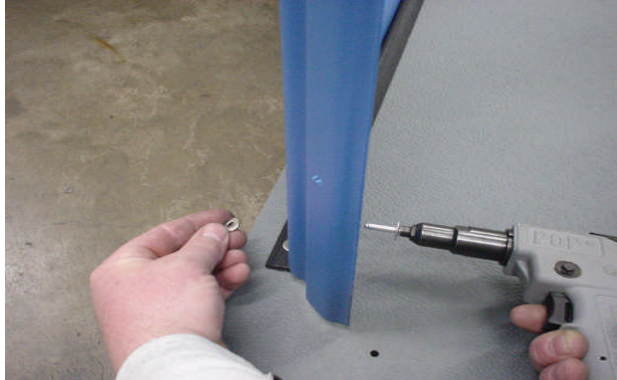

Rivet rear panel to left and right side panel using #68 large flange aluminum rivet install from outside of panel, through the 5th hole up from the bottom of both panels & back-up washer on the inside of panels.

Finish installing remaining rivets & back-up washers in angles/panels. *Tip: a standard flat blade screwdriver may be needed to pry bottom of panel up over exposed rivet/back-up washer attaching angle to floor.



Install Roof on Panels and Finish riveting Panels.

Rivet roof to the panels using #68 large flange aluminum rivets P/N 11054 installed from outside of roof and back-up washers P/N 11315 inside on panel.

Make sure each rivet / back-up washer is properly seated. Finish riveting roof to panels.

Finish riveting side panels to rear panel with #68 rivets / back-up washers.

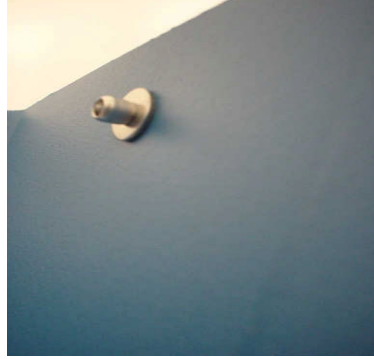

Install Handrails on Panels.

Drill out dimples (4) in left panel with a 1/4" (.250") [6 mm] drill bit, at locations below, (2) in left rear corner & (2) in the middle of panel up about 37.5" [95.25 cm] from floor).

Drill out all dimples (6) in rear panel.

Drill out dimples (2) in right panel in rear corner.

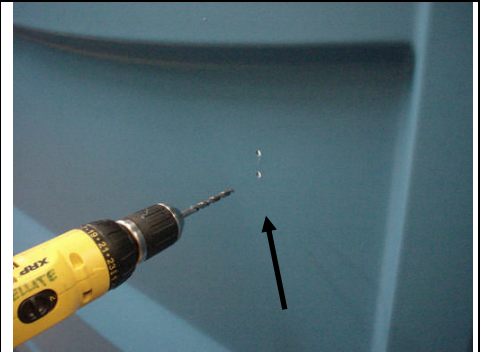
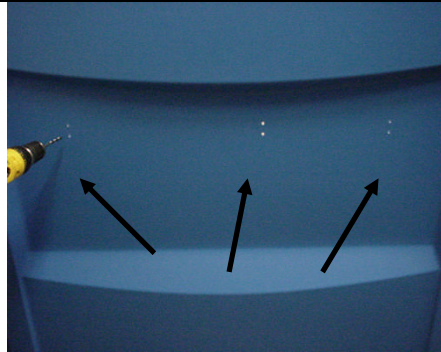
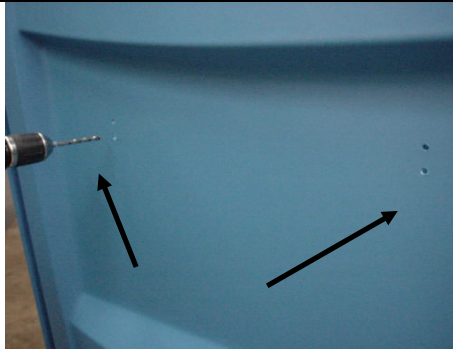

Place 7" [17.78 cm] tube P/N 15589 in short end of one handrail P/N 18038 with at least 3.5" [8.89 cm] left sticking out.

Drill #10 hole through handrail into tube. Install #68 STNLS rivet PN #11270.

Insert Rivet through handrail bracket.



Install 3/16" Fender washer PN 11361 and 3/16" backup washer PN 11315 on outside of panel and set rivet.

Insert long end of handrail onto connecting tube. Rivet handrail to Rear and Right side panel. Drill through handrail with #10 bit and rivet with #68 Stainless Rivet PN# 11270

Insert Plugs PN# 15588 into handrail ends.

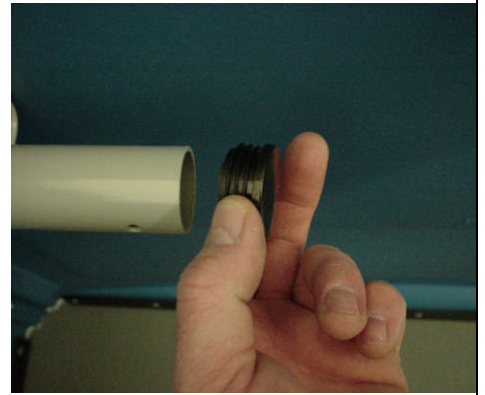
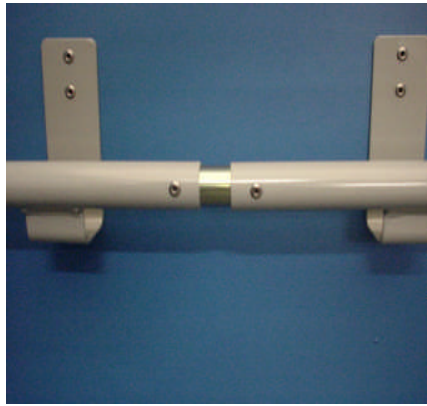
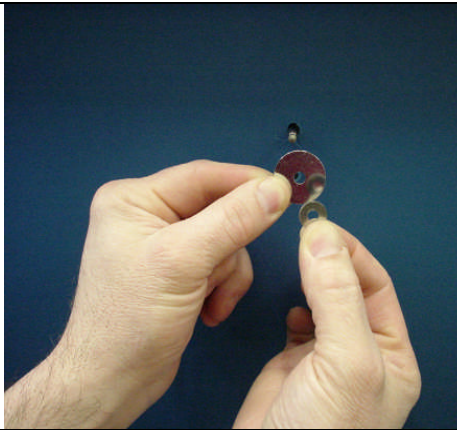

Install the Vent Screens.

Slide vent screen PN# 14112 into pockets from the outside of unit.

Install plastic expanding Rivets PN# 15337 into the 2 outside holes of each screen from the inside of the unit.

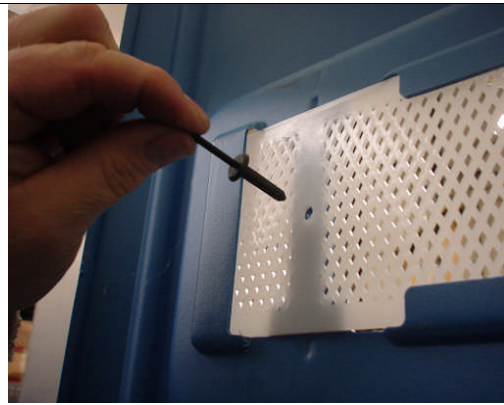

Install Lift Handles.



Locate 6 dimples in panels for each lift handle. One handle goes toward front and one handle toward rear of left and right panel. Drill 1/4" (0.25)[6.35mm] holes through panels.

Rivet handle PN# 14611 to left panel, using #68 STNLS rivets PN# 11270 through handle holes and into outside of panel. Install 3/16" fender washer PN#11361 and 3/16" backup washer PN# 11315 on the rivet from the inside.

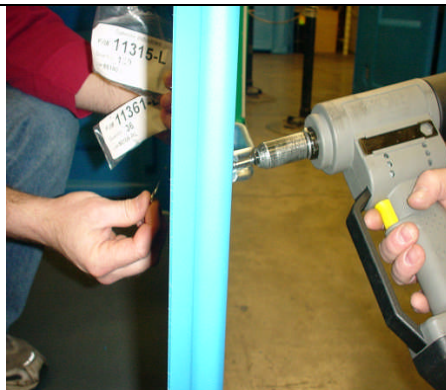
Lift handles placed on right and left sides only as shown.



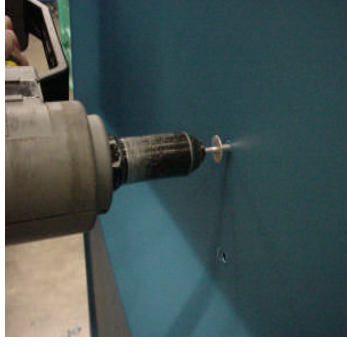

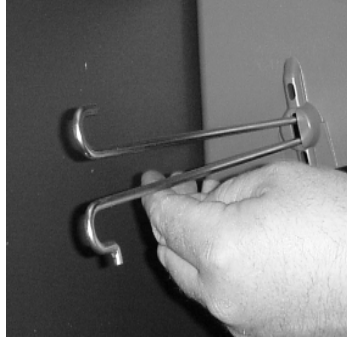

Install Paper guard.

<p>Drill out 4 dimples in left panel using a drill with a 1/4" (.250") [6 mm] drill bit, at location below</p>	<p>Insert large flange #68 Alumium Rivet PN 11054 from the outside of the panel.</p>	<p>Install paperguard PN#17082 and 3/16" back up washer PN# 11315 on the inside.</p>	<p>Insert the spindle PN# 16844 into the paperguard. Note the position of the hook.</p>
			

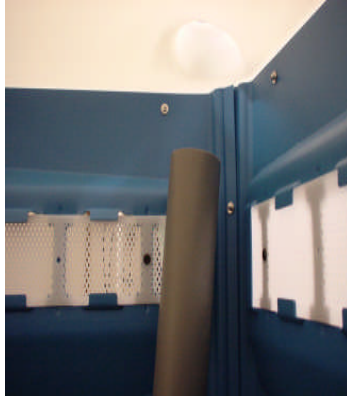

Install Toilet Seat lid.

<p>Install plastic bolt from seat lid PN# 10570 hardware bag through hinge into the tank</p>	<p>Thread plastic nut on from inside of tank.</p>	<p>Phillips driver bit and drill can be use to tighten. Be careful not to over tighten nut.</p>
		



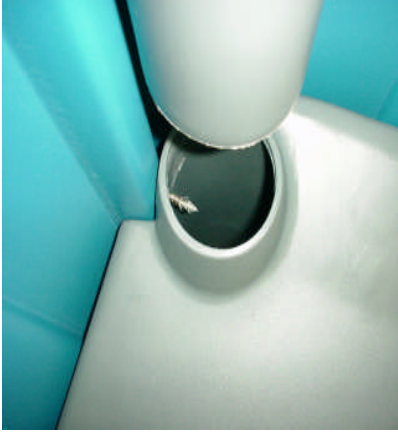

Install Tank and Vent pipe.

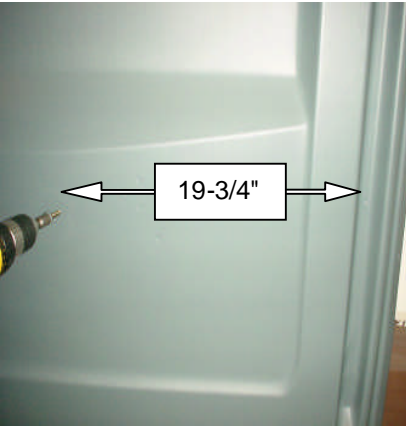
<p>Install vent tube PN# 13796 through the roof opening by pushing upward into roof hole and twisting. Pull pipe down behind handrail. <i>Do not insert into tank until instructed.</i></p>	<p>Place tank PN# 14508 into the corner. Apply pressure out against panel while installing lag screws for the outside of unit.</p>	<p>Install lag screw PN# 13860 from outside. Drive lag through forward dimple in left panel 15-1/2" [39.37] from the rear and 13-1/4" [33.66cm] up from floor.</p>	<p>Drive lag through left panel into dimple in center of groove 17.00" [43.18cm] up from floor.</p>
			

Install Tank and Vent pipe.

<p>Insert vent pipe into tank until it bottoms out against lag screw.</p>	<p>Drive third lag screw through rear panel into dimple in groove to tank and vent pipe at 17-1/2" [44.45cm] up from the floor.</p>	<p>Drive fourth lag screw into rear panel dimple left of the 3rd lag 19-3/4" [50.17cm] and 16-1/2" [41.91cm] up from the floor.</p>
		

Install Front assembly.

<p>Using #68 aluminum large flange rivets PN# 11054 installed from outside and back-up washer PN# 11315 on inside of panel attach the front PN# 18014 to the panels</p>	<p>Place front under roof with left side of front on inside of left side panel. Tuck right side of front over corner of right panel.</p>	<p>Install expanding aluminum rivets PN# 14427 through holes in roof, into front and set rivets.</p>	<p>Place blocks etc. under both sides of floor at front high enough to rivet from the bottom side. Install #610 rivet STNLS PN# 14351 through floor from bottom up through holes on inside of front facing, install backup washers and set rivets.</p>
			

Install Front Assembly

Install (2) L brackets on front side of front assembly in door jamb. Install #68 rivet STNLS PN 11270 from bottom of floor through L bracket and set rivet. Install #68 STNLS rivet PN 11270 through door jamb from inside through L bracket and set rivet.



Install the Decal

Center of decal should be at 60" high. Tip: Top of the decal should line up with 2nd corner rivet from top.



Install Inside Door Handle

Install (2) Avdel black rivet PN 17030 through handle PN 16807, into holes on inside of door and set rivet.



Install Outside Door Handle

With 2 rivets #612 alum. PN 10812 through handle PN 16807. Into holes on outside of door & 2 washers PN 11315 on inside of door.

