

FREEDOM4®

Portable Restroom Assembly Instructions

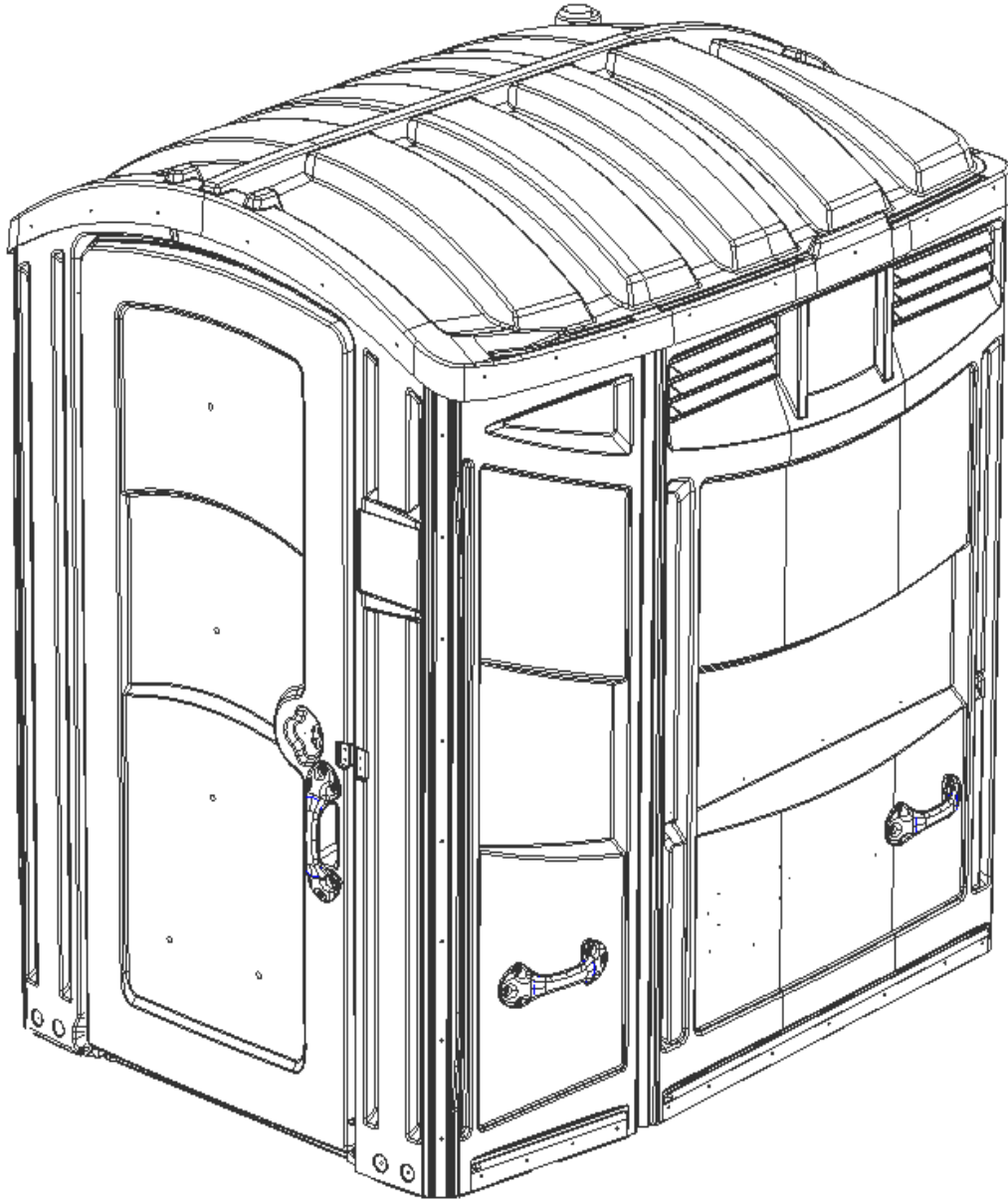

FREEDOM 4 ASSEMBLY INSTRUCTIONS

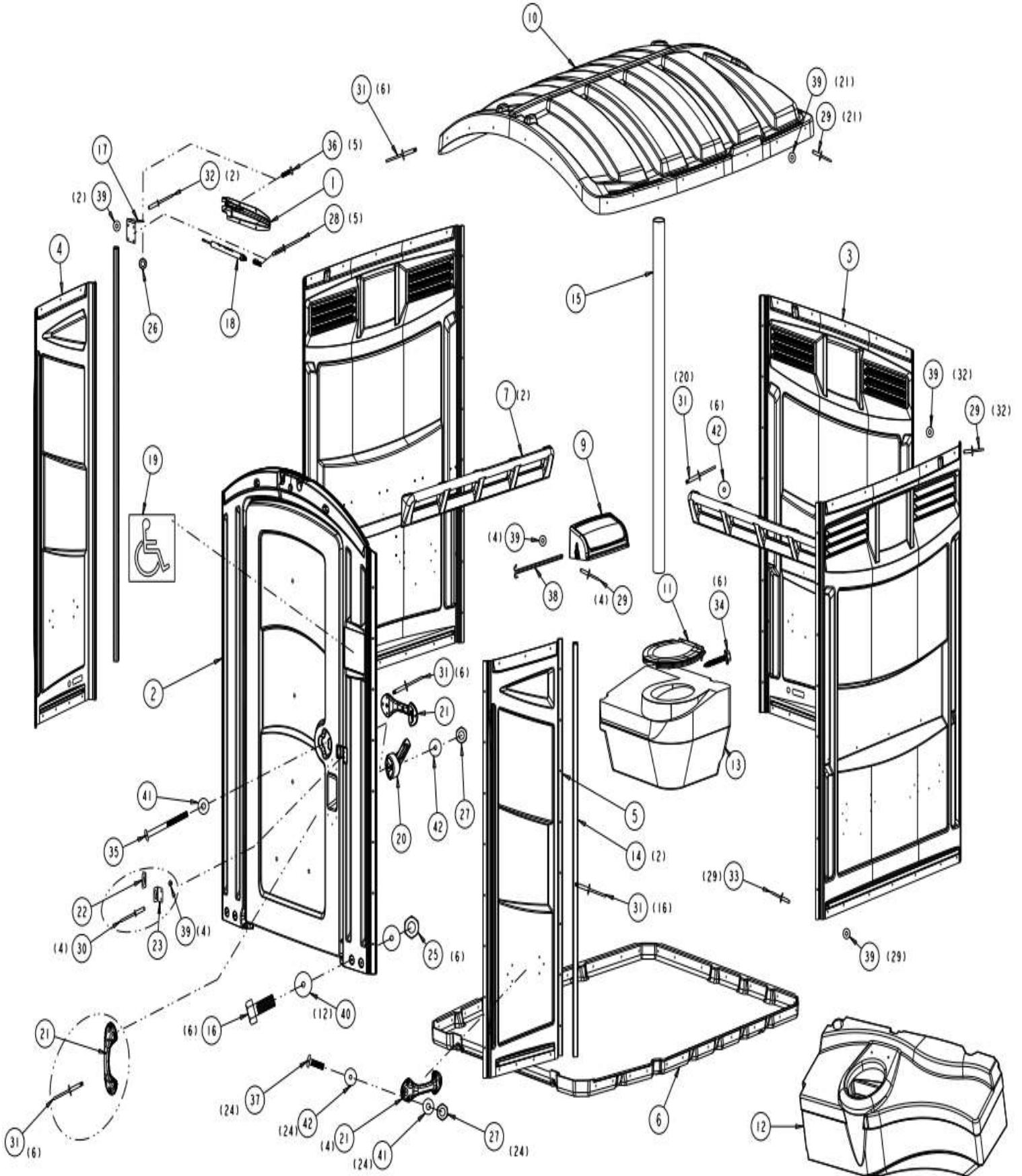

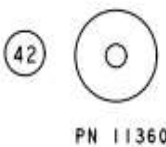
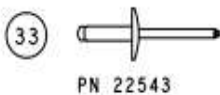
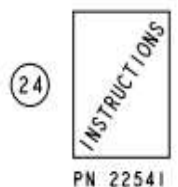
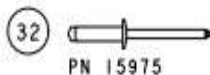
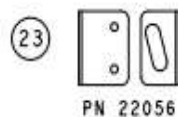
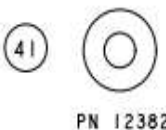
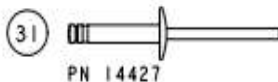
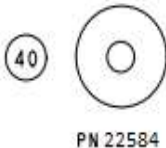
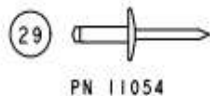
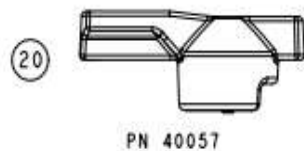
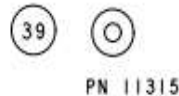
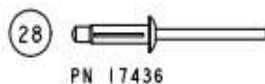
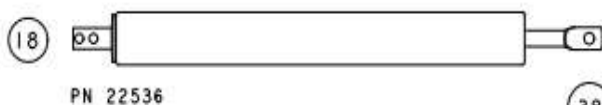
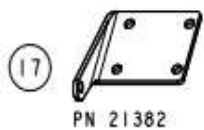
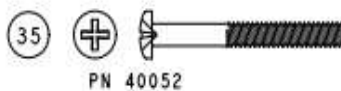
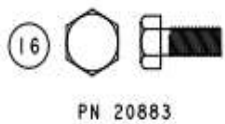

1 HDWE, FREEDOM4 (22540)			
42	11360	31	WASHER, 1/4 ID FENDER STNLS
41	12382	25	WASHER, 1/4 FLAT STNLS
40	22584	12	WASHER, 5/16 ID FENDER HD SS
39	11315	92	WASHER, 3/16 RIVET STNLS
38	22310	1	SPINDLE, PRGRD 11 3 ROLL METAL
37	18718	24	SCREW, 1/4-20 x 1 TRUSS HEAD
36	18813	5	SCREW, #10-24 X3/4 TRUSS STNLS
35	40052	1	SCREW, 1/4-20x3-1/2 PH PHHD SS
34	13860	6	SCREW, 1/4 X 1-1/2 W/WSH GOLD
33	22543	29	RIVET, #610 AAL POP
32	15975	2	RIVET, #66 STNLS
31	14427	54	RIVET, #66 LSH W/LOCK MANDREL
30	11270	4	RIVET, #68 STNLS
29	11054	57	RIVET, #68 AAL POP
28	17436	5	RIVET, AVDEL SILVER
27	16307	25	NUT, 1/4-20 NYLOC STNLS
26	14777	1	NUT, #10-24 NYLOC
25	13131	6	NUT, 5/16 NYLOC
24	22541	1	INSTRUCTION, FREEDOM4
23	22056	1	HASP, EXTENDED
22	13197	1	HASP, 3/16 RIVET HOLE DOOR
21	22522	6	HANDLE, PLASTIC LIFT DGRY
20	40057	1	HANDLE, GB TOILET GREY
19	10394	1	DECAL, HCP (1SA) FREEDOM2
18	22536	1	CLOSURE, DOOR HYDRAULIC 1X16
17	21382	1	BRACKET, FREEDOM3 CLOSURE
16	20883	6	BOLT, 5/16-18 X 1 HXHD STNLS

15	13796	1	VENT PIPE, 3 X 65-1/2 BLACK
14	22537	2	TUBE- FREEDOM4 STIFFENER BLK
13	14508	1	TANK, FRE/LIB 35 GAL CAPACITY
12	16538	1	TANK, FRE/LIB LARGE DGRY
11	10570	1	SEAT, TOILET TUF/FRE/LIB BLACK
10	22518	1	ROOF- FREEDOM4 NATURAL
9	22209	1	HOOD- PAPERGRD 3 ROLL DGRY
8	22540	1	HDWE, FREEDOM4
7	22519	2	GRAB BAR- LIB/FRDM4 PLASTIC
6	22520	1	FLOOR- FREEDOM4
5	22535	1	DESIGN- PANEL HALF RIGHT FRDM4
4	22534	1	DESIGN- PANEL HALF LEFT FRDM4
3	22517	3	DESIGN- LIBERTY/FR4 SIDE PANEL
2	22516	1	DESIGN- FREEDOM4 FRONT ASSY
1	22523	1	COVER-FREEDOM4 DOOR CLOSER
ITEM #	PART #	QTY	DESCRIPTION

INTRODUCTION

Satellite portable restrooms must be assembled according to approved assembly procedures. Avoid variations in assembly procedures which could adversely affect product life and warranty.

All references to front, left, right, and rear are looking at the door of the unit from the outside.

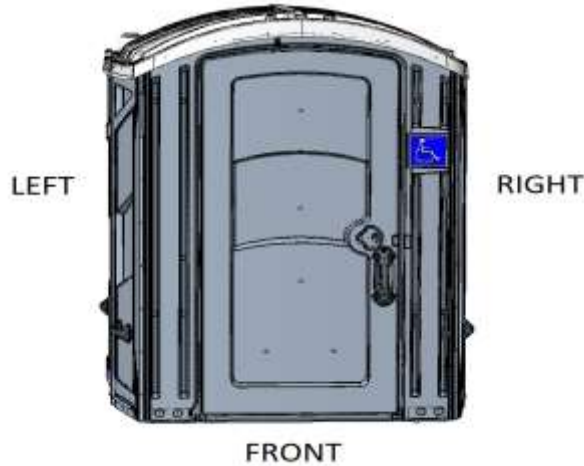

Tools:

•Standard screwdriver	•Drill Electric or Cordless Drill	•# 2 Phillips Head Driver Bit •# 3 Phillips Head Driver Bit	•3/8" (.375") [9.53 mm] Hex Driver bit
•Pop Rivet Gun	•#10 (.193") [5 mm] Drill bit	•1/4" (.250") [6 mm] Drill bit	•5/16" (.312") [7.64 mm] drill bit
•1/2" (.500") [12.2 mm] Open end wrench	• 1/2" (.500") [12.2 mm] socket or socket driver bit	• Adjustable wrench	•7/16" (.437") [11.1 mm] socket or socket driver bit

HELPFUL HINTS:

- **Keep panels out of direct sunlight.**
- **Don't open up all of your kit boxes. Open up only enough kit boxes to assemble the number of toilets you are currently working on. KEEP PARTS ORGANIZED.**
- **Staging parts will minimize assembly time.**

Rivet rear/side panels to floor:

1) Rivet rear panel to floor. Position panel on outside of floor so lip extending out from floor fits in bottom channel in panel & holes in bottom of panel are in line with holes in floor.	2) Rivet rear panel to floor. Install (7) rivets P/N 22543 from inside unit through holes in floor and into holes in panel. Place (7) washers P/N 11315 onto rivets on outside of unit.	3) Rivet left & right side panels to floor. Position panels on outside of floor so lip extending out from floor fits in bottom channel in panels & holes in bottom of panels are in line with holes in floor. Install (7 per panel) rivets P/N 22543 from inside unit through holes in floor and into holes in panel. Place (7 per panel) washers P/N 11315 onto rivets on outside of unit. Install lag screw PN 13860 in hole in each corner to hold rear & side panels together.
----------------------------------------------------------------------------------------------------------------------------------------------------------------------------------------------	-----------------------------------------------------------------------------------------------------------------------------------------------------------------------------------------	------------------------------------------------------------------------------------------------------------------------------------------------------------------------------------------------------------------------------------------------------------------------------------------------------------------------------------------------------------------------------------------------------------------------------------------------------------------------------------



Install lift handles on Half panels:

4) Use (6) screws PN 18718 with (6) washers PN 11360 on inside of half panel, through 6 pre-drilled holes in half panel for mounting lift handle.

5) Place lift handle PN 22522 on outside of panel with screws PN 18718 through holes in handle. Install (6) washer PN 12382 & (6) nuts PN 16307 on screws using # 3 Phillips Head Driver Bit & 7/16" (.437") [11.1 mm] socket or socket driver bit.

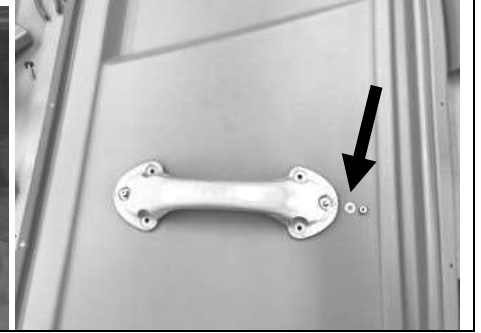
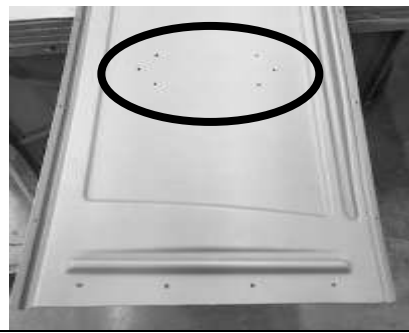
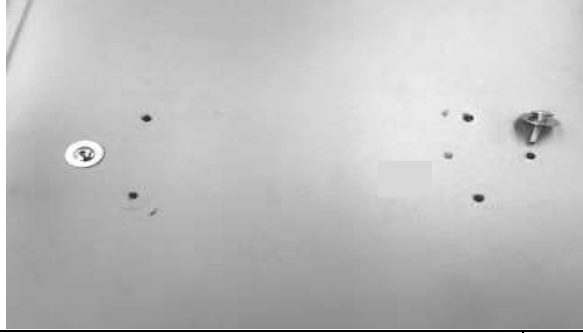

Rivet half panels to Floor:

6) Rivet left half panel to floor. Position panel on outside of floor so lip extending out from floor fits in bottom channel in panels & holes in bottom of panels are in line with holes in floor.

7) Rivet left half panel to floor. Install (4) rivets P/N 22543 from inside unit through holes in floor, into holes in panel. Place (4) washers P/N 11315 onto rivets outside of unit.

8) Repeat steps 6) & 7) riveting right half panel to floor.



Rivet Half Panels to side Panel & Stiffener Tube:

9) Rivet Left half panel to left side panel (**left side panel overlaps left half panel**).

10) Rivet left half panel & left side panel. Place stiffener tube PN 22537 on outside of unit where panels are joined, with holes in stiffener tube in line with holes in panels.

11) Install (8) rivets P/N 14427 from inside unit through panel / facing holes into holes in stiffener tube. **Note: hold rivet gun towards right & not straight into holes panels/stiffener tube, due to stiffener tube being positioned at an angle on outside of panels. "Repeat steps 10) & 11) on right half panel, holding rivet gun to the left (right half panel overlaps right side panel).**

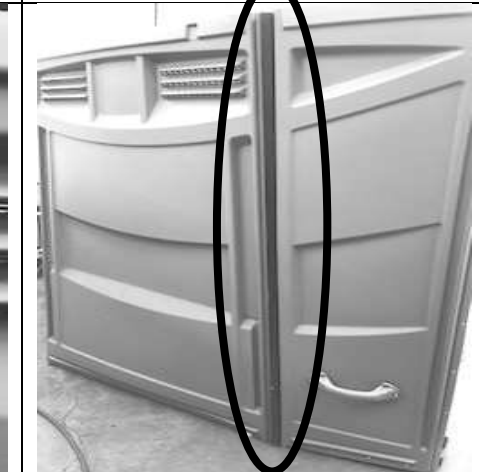

Rivet panels (left / right / rear) together in rear corners:

Install lift handles on side panels:

12) Rivet panels (left / right / rear) together in rear corners. Left corner (**rear panel overlaps left side panel**). Right corner (**right side panel overlaps rear panel**).

13) Rivet panels (left / right / rear) together in rear corners. Use (8) rivets per corner P/N 11054 from outside of panel & (8) washers per corner P/N 11315 inside unit on rivet.

14) Drill at 6 dimple locations near rear corners of left / right side panel using a 1/4" (.250") [6 mm] Drill bit.



15) Use (6) screws PN 18718 with (6) washers PN 11360 on inside of side panel, through 6 holes in side panel for mounting lift handle.

16) Place lift handle PN 22522 on outside of panel with screws PN 18718 through holes in handle. Install (6) washer PN 12382 & (6) nuts PN 16307 on screws using # 3 Phillips Head Driver Bit & 7/16" (.437") [11.1 mm] socket or socket driver bit.

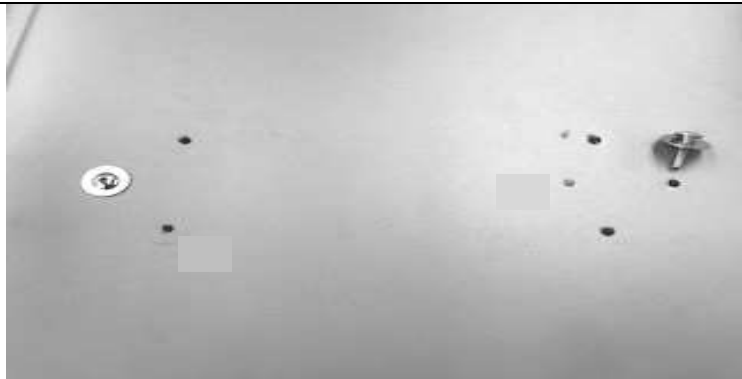

Install paperguard:

17) Drill out 4 marks ("0") in left panel from inside unit using a drill with a 1/4" (.250") [6 mm] drill bit, at location shown below.

18) Install paperguard PN 22209 with (4) rivets PN 11054 outside of panel and (4) washers PN 11315 inside of unit on rivet.

19) Insert the spindle PN 22310 into the paperguard. Note: position of the hook.

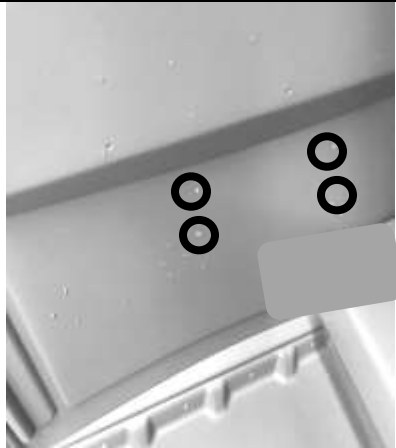

Install “Tank option PN 16538” and Vent pipe:

20) Install seat lid PN 10570 (comes with plastic bolts & nuts) on tank PN 16538. Plastic bolt through seat lid hinge into the tank Thread plastic nut on bolt from inside of tank. Position tank in left rear corner of unit.



21) Hold tank against panel while installing screws (3) PN 13860 from outside of unit in dimples in left panel shown below using 3/8" (.375") [9.53 mm] Hex Driver bit.



22) Insert vent pipe PN 13796 into tank PN 16538 until it bottoms out against screw.



23) Drive fourth screw PN 13860 through rear panel into dimple in finger groove into tank and vent pipe using 3/8" (.375") [9.53 mm] Hex Driver bit.



24) Drive fifth screw PN 13860 through rear panel into tank.

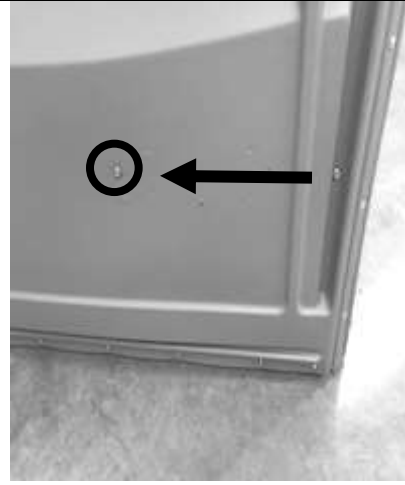

25) Drive fifth screw through rear panel into tank. In line with dimple & up from dimple as shown in rear panel using 3/8" (.375") [9.53 mm] Hex Driver bit.



26) Drive sixth screw through “X” rear panel centered between dimples, as shown below. (Right rear corner)

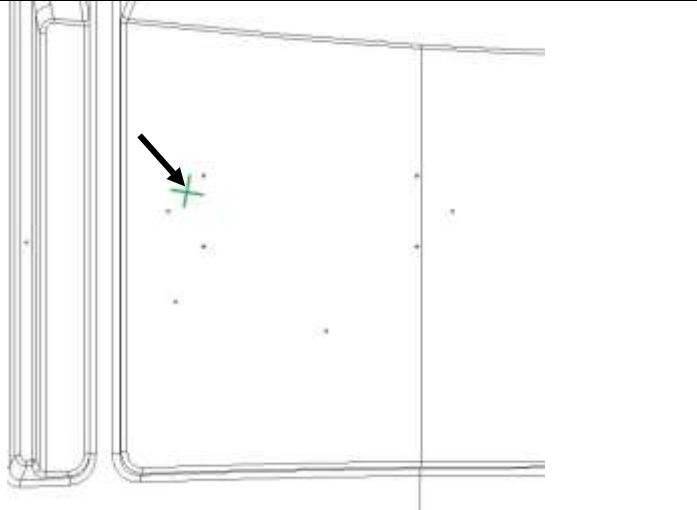

27) Note sixth screw through rear panel is centered between dimples in far right rear corner as shown.



Install “Tank Option PN 14508” and Vent pipe:

28) Install seat lid PN 10570 (comes with plastic bolts & nuts) on tank PN 14508. Plastic bolts through seat lid hinges into the tank. Thread plastic nuts on bolts from inside of tank. Position tank in left rear corner of unit.



29) Hold tank against panel while installing (3) screws PN 13860 from outside of unit in dimples in left panel shown below using 3/8" (.375") [9.53 mm] Hex Driver bit.



30) Insert vent pipe PN 13796 into tank PN 14508 until it bottoms out against screw.



31) Drive fourth screw PN 13860 through rear panel into dimple in finger groove to tank and vent pipe using 3/8" (.375") [9.53 mm] Hex Driver bit.



32) Install fifth & sixth screw in dimples rear panel as shown.



Install Front assembly:

33) Rivet front to half panels. Position left side half panel over left facing of front with holes in panels in line with holes in left front facing (**left side half panel overlaps front left facing**).



34) Rivet half panel to front facing using (8) rivets PN 11054 from outside of panel/front facing & (8) washers P/N 11315 on rivet inside unit.



35) Rivet front to half panels. Position right facing of front over right side half panel with holes in panels in line with holes in right front facing (**front right facing overlaps right side half panel**). Rivet panel to front facing, repeat step 34).



Install Front assembly:

36) Make sure front pocket on inside of front is up over vertical wall of floor. Front gap between door & right facing of front should be no more than .250" [6 mm]. The gap between the facing and the ground should be .250 [6mm].

37) In right front facing there are 3 pre-drilled holes in the bottom. With front in position on floor transfer drill through 3 holes in facing into floor using 5/16" (.312") [7.64 mm] drill bit.

38) Install (3) bolts PN 20883 with (3) washers PN 22584 in holes in bottom of front right facing into floor.

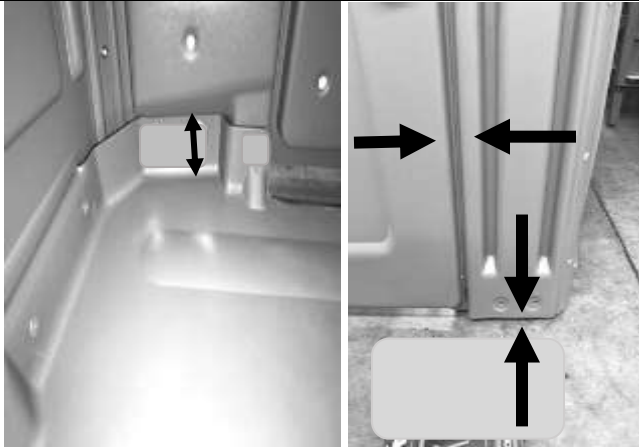

39) On inside of front place (3) washers PN 22584 & (3) nuts PN 13131 on bolts in right front facing into floor. Tighten nuts on bolts using 1/2" (.500") [12.2 mm] socket or socket driver bit & 1/2" (.500") [12.2 mm] Open end wrench.

40) Repeat steps 36) through 39) to install bolts & nuts in left front facing into floor.

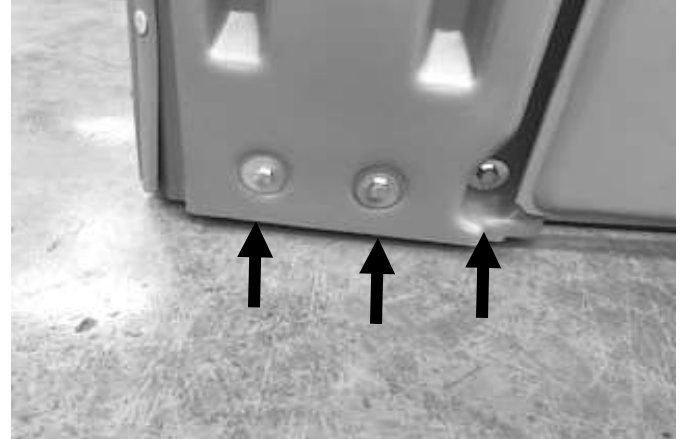
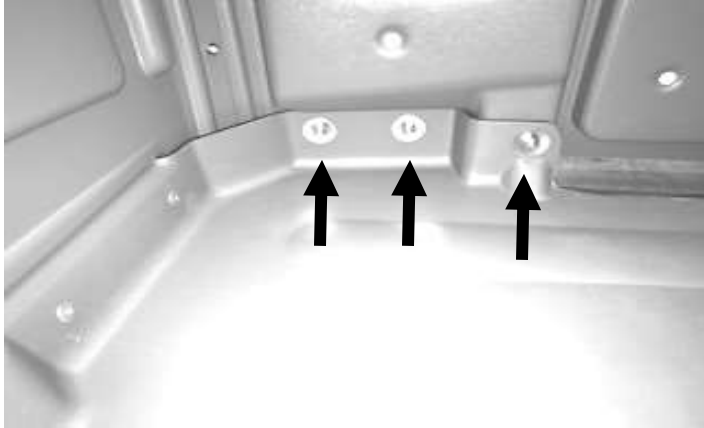

Install Roof:

41) Place roof PN 22518 on unit, with hole in roof for vent pipe in left rear corner. Pull roof down over vent pipe. Align holes in roof with holes in rear & side panels. Rivet roof to rear & side panels using rivets P/N 11054 installed from outside of roof and washers PN 11315 inside unit on rivets.

42) Rivet roof to rear panel using (5) rivets P/N 11054 installed from outside of roof & (5) washers P/N 11315 inside unit on rivets.

43) Rivet roof to side panels using (8) rivets P/N 11054 per side installed from outside of roof and (8) washers P/N 11315 per side inside unit on rivets.

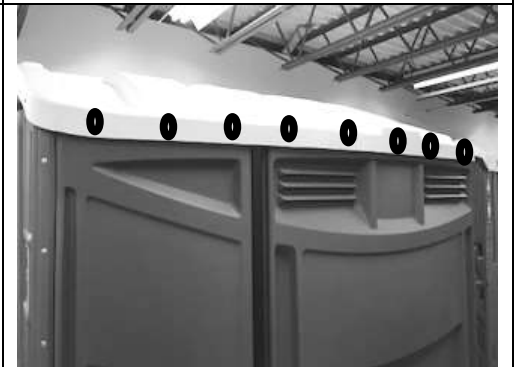

Install Roof:

44) Rivet roof to top of front. **“First place block of wood under bottom of door on right side (2 pcs. of 2x4 stacked would work)”**.



45) Rivet roof to front door frame. “Pull roof down & transfer drill through holes in roof into top door frame of front **(be careful not to drill through 2nd wall of front top facing)** using #10 (.193”) [5 mm] Drill bit. Rivet roof to front top facing with (6) rivets PN 14427



Install the Decal:

46) Place Decal PN 10394 on right facing of front as shown.



Install Front Hasps:

47) Locate dimples for hasp PN 13197 on door, drill at dimple locations using #10 (.193”) [5 mm] Drill bit. Rivet hasp to door using (2) rivets PN 11270 outside & (2) washers PN 11315 on rivets inside of door. Hasp PN 22056 on right facing, drill at dimple locations using #10 (.193”) [5 mm] Drill bit. Rivet hasp to facing using (2) rivets PN 11270 through hasp into facing & (2) washers PN 11315 on rivets inside of facing.

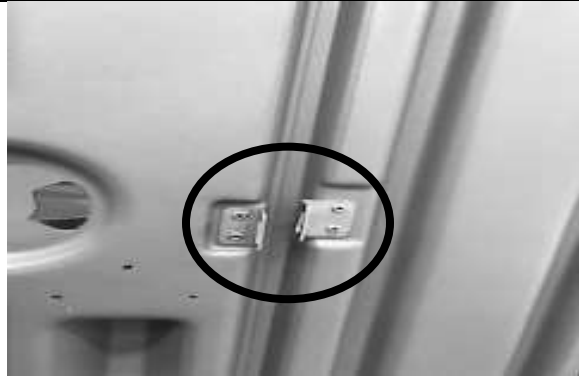

Install Outside Door Handle:

48) Drill out (6) dimples outside of door using #10 (.193”) [5 mm] Drill bit **(be careful not to drill through 2nd wall of door facing)**.



49) Rivet handle PN 22522 on outside of door using (6) rivets PN 14427.



Install door handle / latch:

50) Place handle PN 40057 on inside of door (recessed area). From outside door insert screw 40052 (3-1/2”) with washer PN 11360 in hole in door through handle on inside of door.

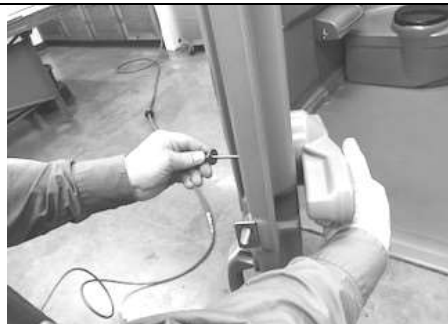

51) Place washer PN 12382 & nut PN 16307 on screw in recess of handle. Tighten screw/nut using # 3 Phillips Head Driver Bit & 7/16” (.437”) socket. Tighten screw/ nut so handle is snug & not too loose that it could fall into closed position on its own.



52) Handle when in open position, green color should be seen in indicator window of door. Red in color when handle is in closed position.



Install Door Closure / Door closure cover:

53) Drill at dimples (4) on inside of left facing (pocket for door closure bracket) using #10 (.193") [5 mm] Drill bit. **(be careful not to drill through outside wall of left facing or door).**

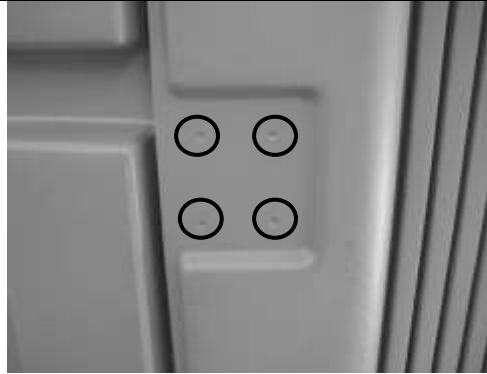

54) Place door closure bracket PN 21382 on facing inside of door as shown. Install (2) rivets PN 17436 in inside holes of bracket. Use (2) rivets PN 15975 in outside holes of bracket & (2) washers PN 11315 on outside of facing.

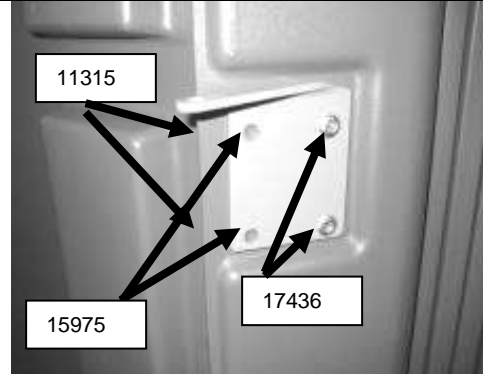

55) Locate & drill out (2) dimples on inside of door to mount door closure bracket to door (included with door closure) using #10 (.193") [5 mm] Drill bit **(be careful not to drill through 2nd wall of door).**

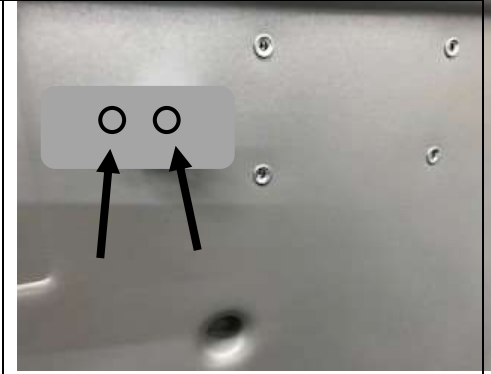

56) Rivet door closure bracket to door (included with door closure). Install bracket completely to the left using (2) rivets PN 17436 Add 3rd rivet far left of bracket, drill hole through bracket into door using #10 (.193") [5 mm] Drill bit.

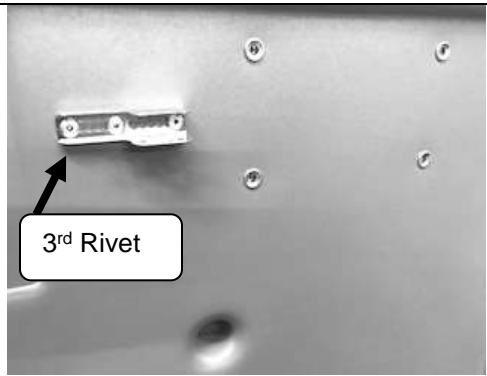

57) Fasten closure PN 22536 rod to bracket PN 21382. Place rod on top bracket arm. Fasten closure rod to bracket arm with screw PN 18813 and nut PN 14777 using # 2 Phillips Head Driver Bit & adjustable wrench. **Just snug screw/nut do not overtighten, so rod can move.**

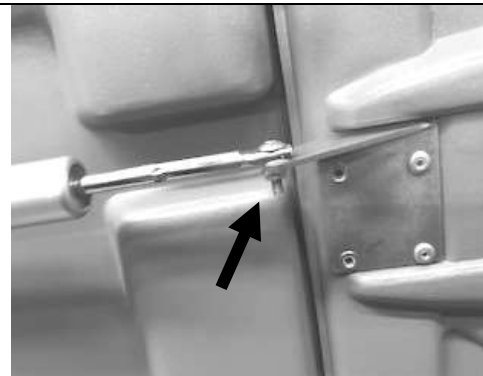

58) Attach door closure to bracket on door with pin (provided with closure). **NOTE: adjust closure speed by turning cylinder (follow instructions on cylinder for direction to turn "small print"). A minimum of 5 second time frame for door to close.**

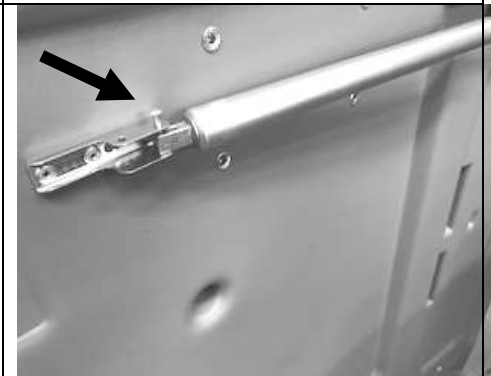

59) Locate 4 inserts on inside of door to mount closure cover.



60) Install door closure cover PN 22523 to door with (4) screws PN 18813 Start screws by hand into inserts. Then use # 2 Phillips Head Driver Bit only snug screws in inserts do not overtighten.



61) **Install handle on inside of door:** Drill out (6) dimples inside of door just above closure cover, using #10 (.193") [5 mm] Drill bit **(be careful not to drill through 2nd wall of door facing).** Rivet handle PN 22522 on inside of door using (6) rivets PN 14427.

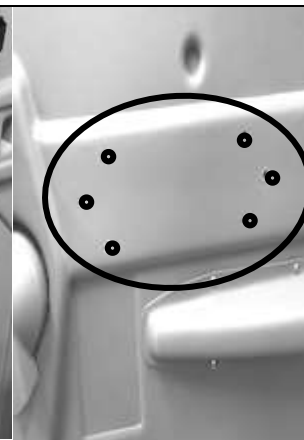

INSTALL GRAB BAR ON REAR PANEL: 62) Drill at 5 lower dimple & 5 upper vertical "O" locations shown below using #10 (.193") [5 mm] Drill bit on inside of panel.

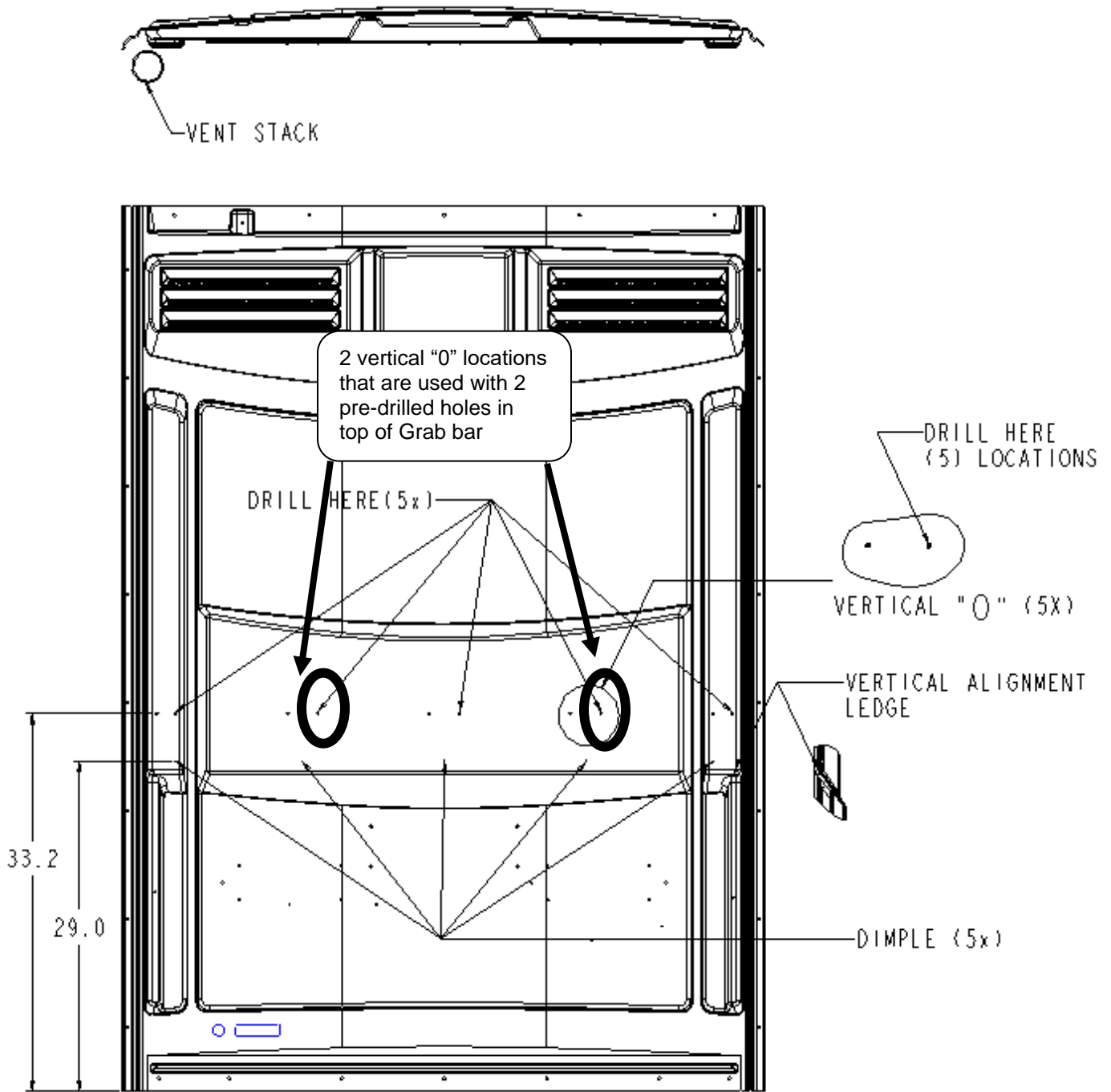

**REAR PANEL
INSIDE VIEW**

Rivet Grab bar to rear panel (from outside of unit): 63) "Place Grab Bar on inside of rear panel, make sure bottom of Grab Bar is resting on vertical alignment ledges 2 per panel, shown above" Outside of rear panel use (2) rivets PN 14427 in 2 vertical "0" hole locations in rear panel through into 2 pre-drilled holes in Grab Bar. Then transfer drill into Grab Bar through remaining (8) holes drilled in rear panel using #10 (.193") [5 mm] Drill bit (**be careful not to drill through 2nd wall of Grab Bar**). Install (3) rivets PN 14427 with (3) washers PN 11360 in remaining 3 upper holes in rear panel into Grab bar. Install (5) rivets PN 14427 in 5 lower holes in rear panel into Grab Bar as shown below.

2 pre-drilled holes in top of Grab Bar are in line with 2 vertical "0" holes noted in rear panel.

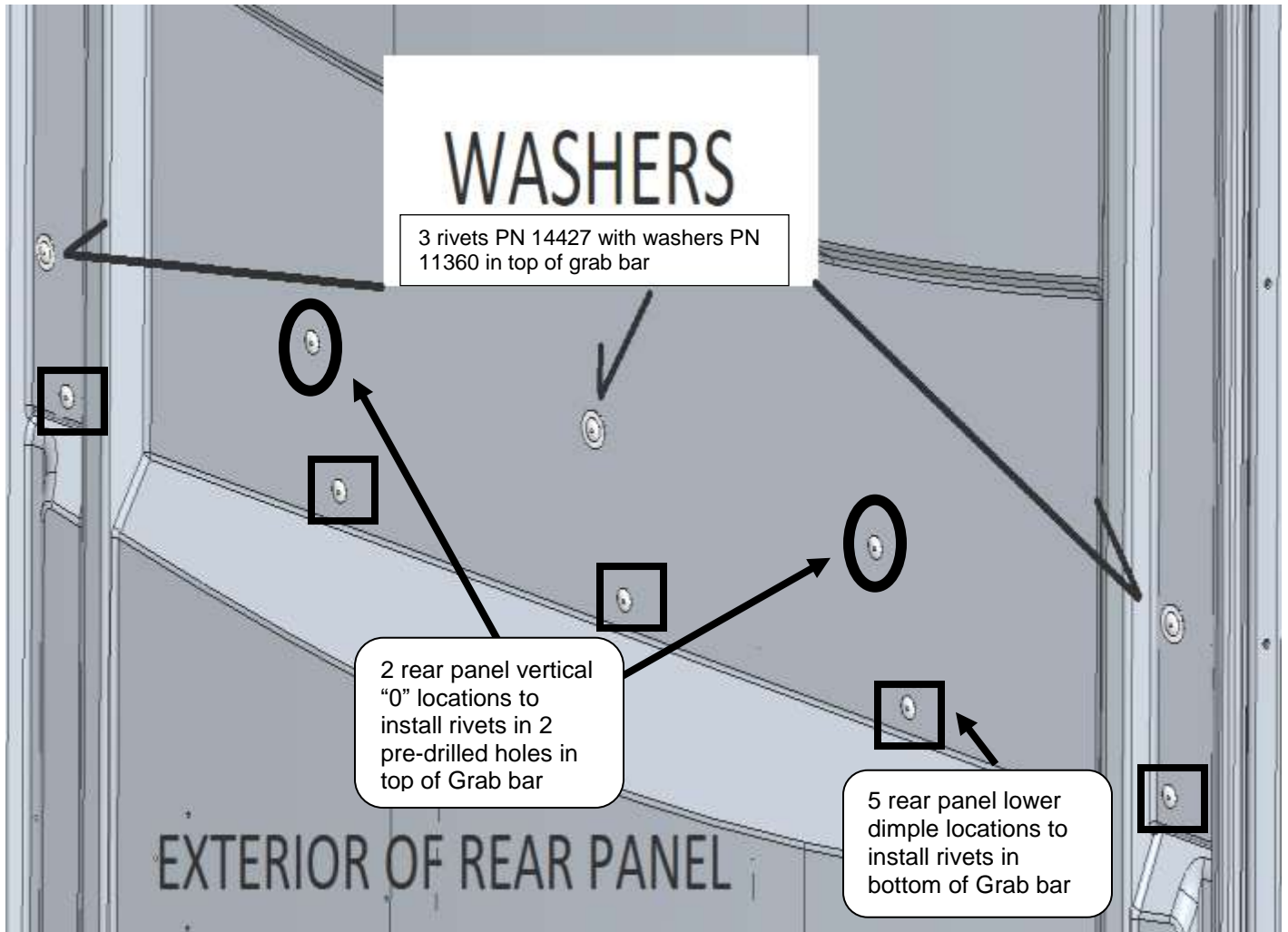
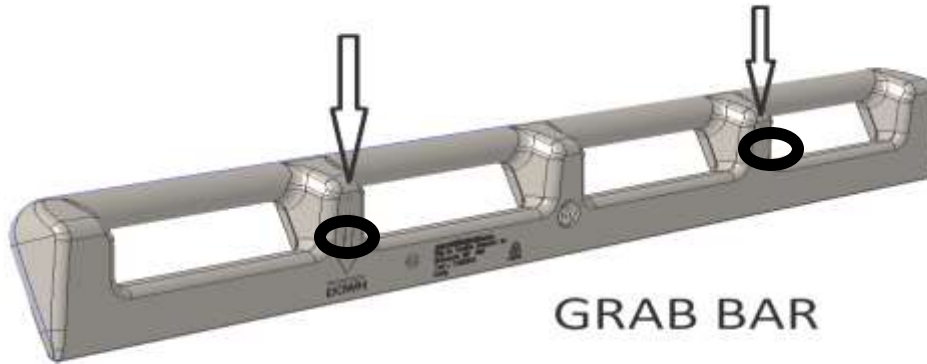

INSTALL GRAB BAR ON LEFT PANEL: 64) Drill at 5 lower dimple & 5 upper horizontal "o" locations shown below using #10 (.193") [5 mm] Drill bit on inside of panel.

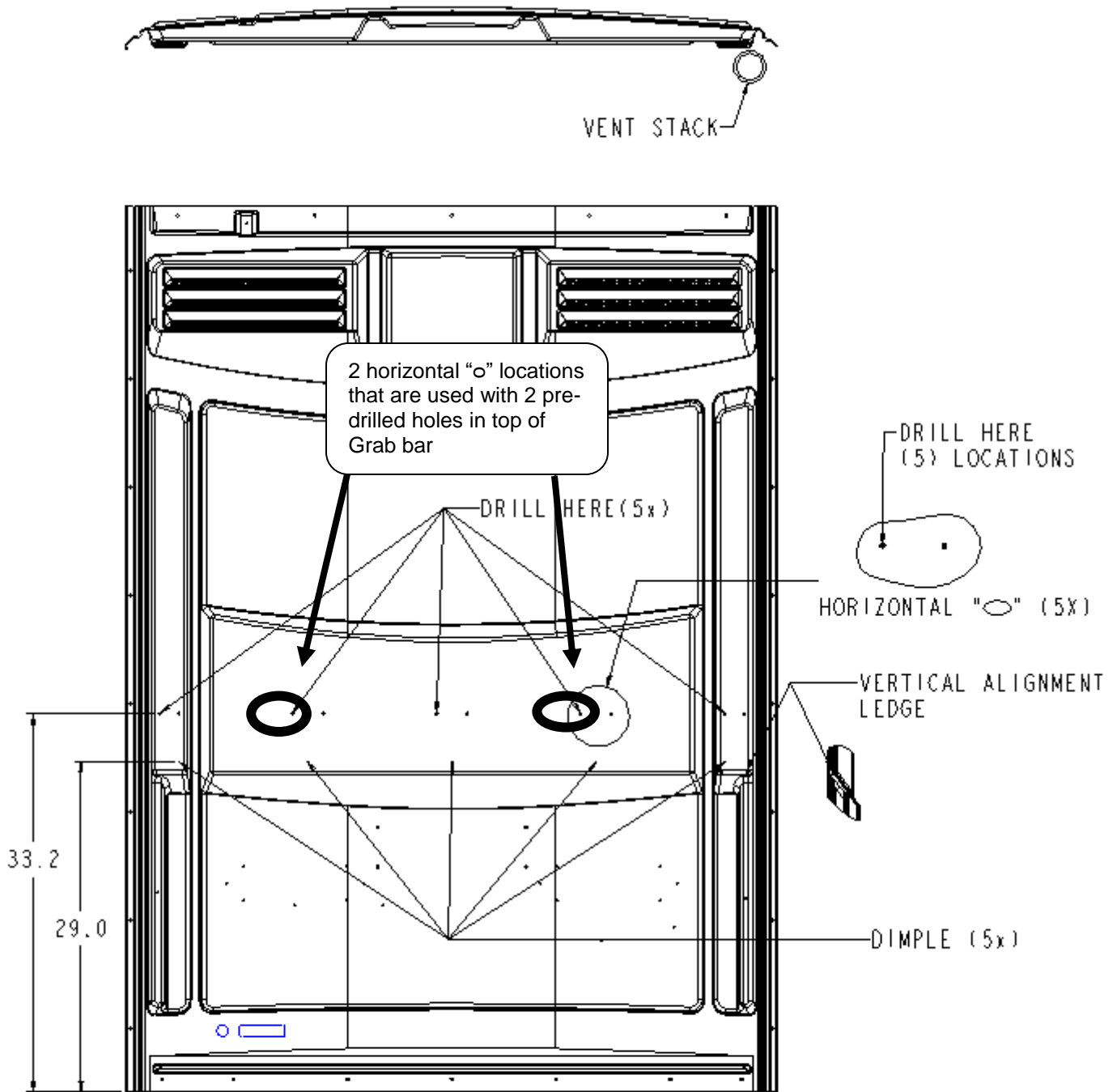

**LEFT PANEL
INSIDE VIEW**

Rivet Grab bar to left panel (from outside of unit): 65) "Place Grab Bar on inside of left panel, make sure bottom of Grab Bar is resting on vertical alignment ledges 2 per panel, shown above" Outside of left panel use (2) rivets PN 14427 in 2 horizontal "o" hole locations in rear panel through into 2 pre-drilled holes in Grab Bar. Then transfer drill into Grab Bar through remaining (8) holes drilled in left panel using #10 (.193") [5 mm] Drill bit (**be careful not to drill through 2nd wall of Grab Bar**). Install (3) rivets PN 14427 with (3) washers PN 11360 in remaining 3 upper holes in rear panel into Grab bar. Install (5) rivets PN 14427 in 5 lower holes in left panel into Grab Bar as shown below.

2 pre-drilled holes in top of Grab Bar are in line with 2 horizontal "o" holes noted in left panel.

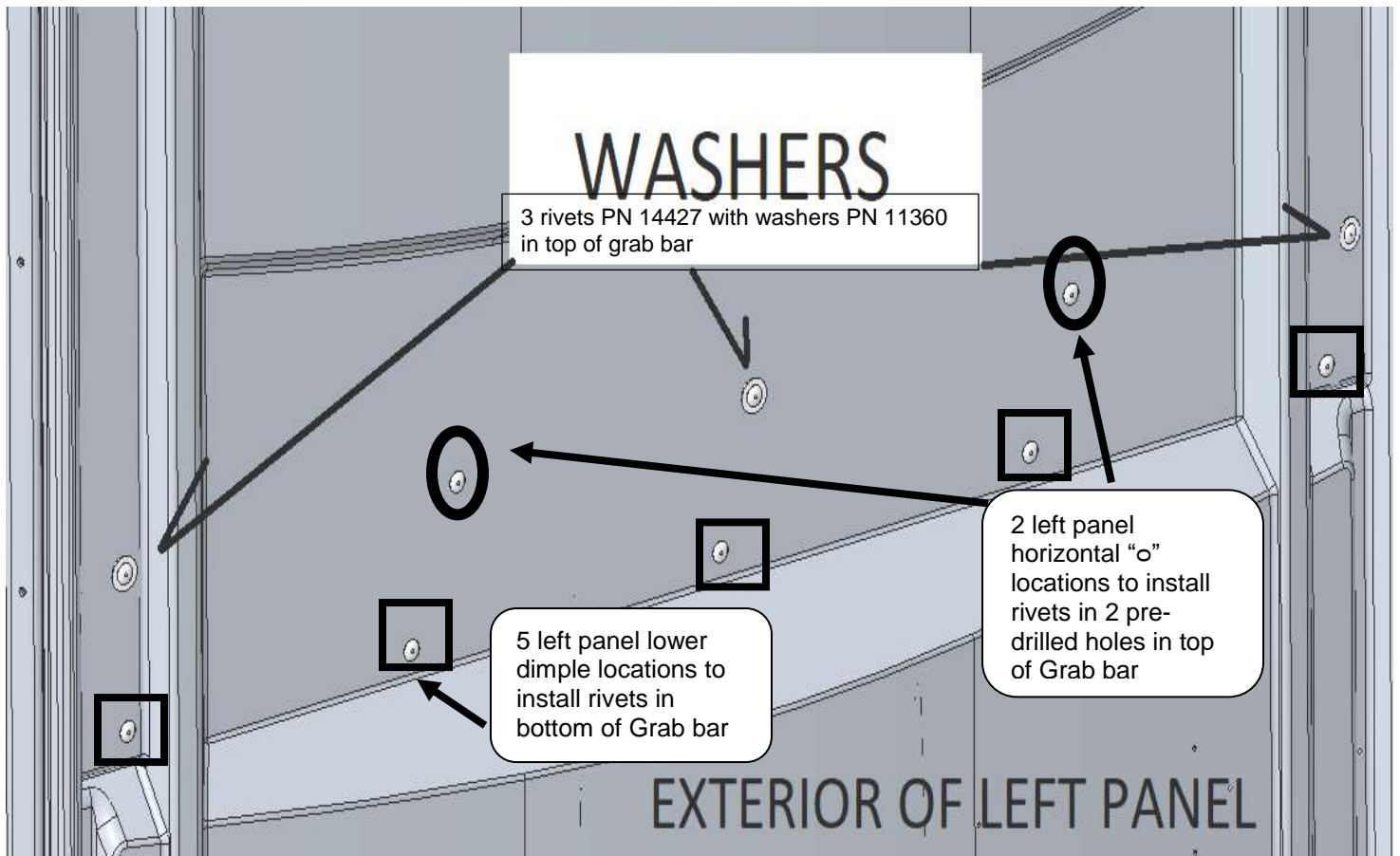
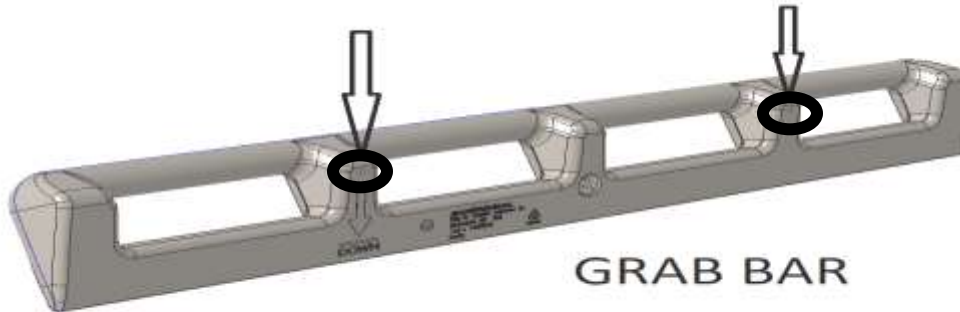

2530 Xenium Lane North, Minneapolis, MN 55441
 Telephone: 763-553-1900 Fax: 763-553-1905
 800-328-3332 / www.satelliteindustries.co